

Chapter 4

The Von Neumann Model

The Stored Program Computer

1943: ENIAC

- **Presper Eckert and John Mauchly -- first general electronic computer.**
(or was it John V. Atanasoff in 1939?)
- **Hard-wired program -- settings of dials and switches.**

1944: Beginnings of EDVAC

- **among other improvements, includes program stored in memory**

1945: John von Neumann

- **wrote a report on the stored program concept,
known as the *First Draft of a Report on EDVAC***

The basic structure proposed in the draft became known as the “von Neumann machine” (or model).

- **a memory, containing instructions and data**
- **a processing unit, for performing arithmetic and logical operations**
- **a control unit, for interpreting instructions**

For more history, see <http://www.maxmon.com/history.htm>

Von Neumann Model

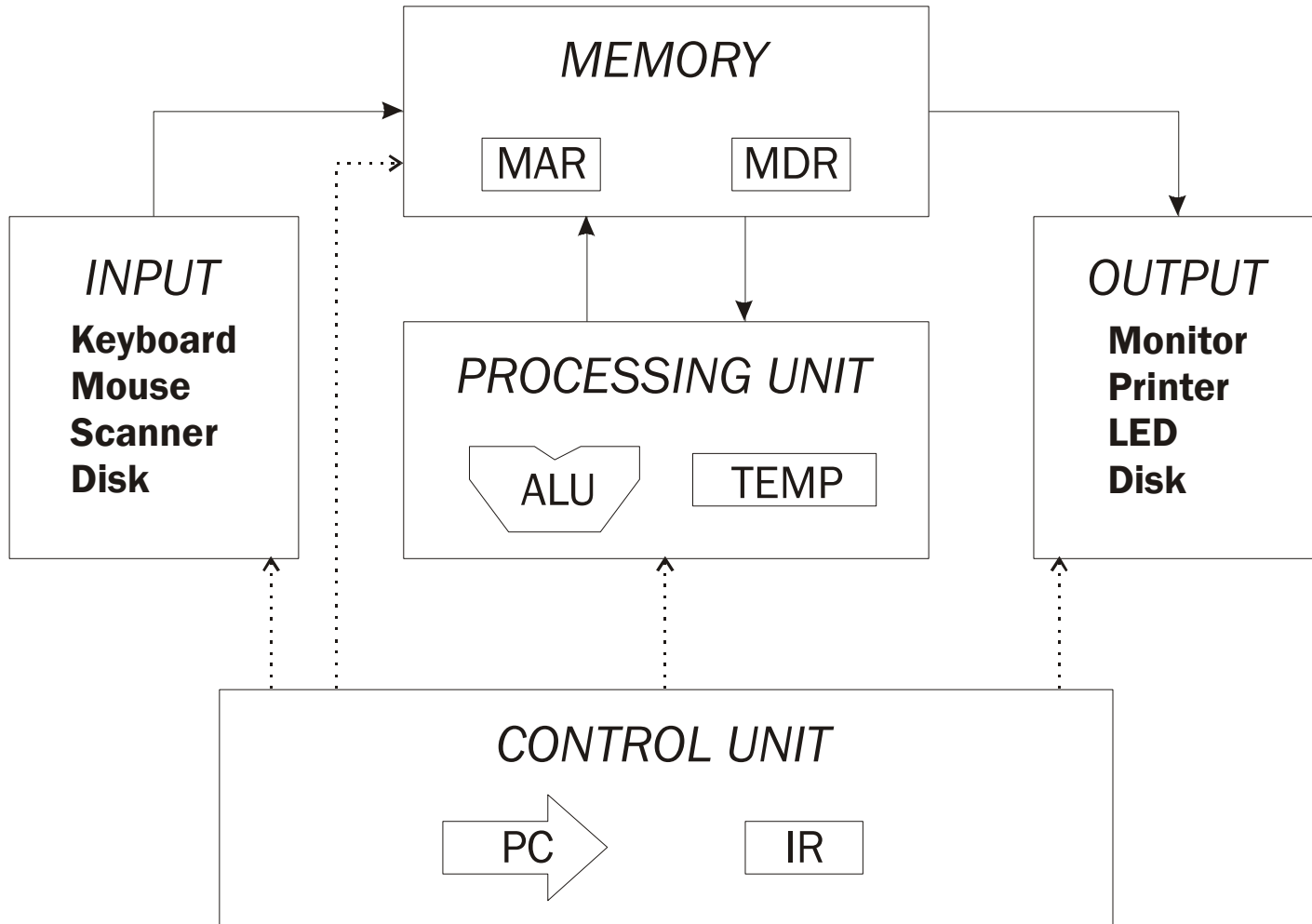

Memory

$2^k \times m$ array of stored bits

Address

- unique (k -bit) identifier of location

Contents

- m -bit value stored in location

Basic Operations:

LOAD

- read a value from a memory location

STORE

- write a value to a memory location

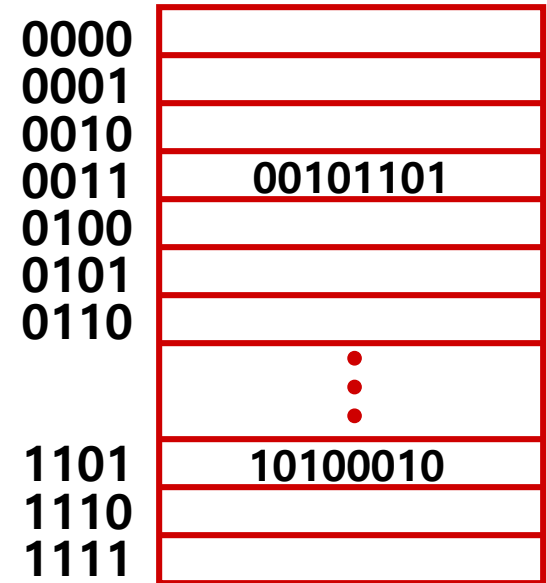

Interface to Memory

How does processing unit get data to/from memory?

MAR: Memory Address Register

MDR: Memory Data Register

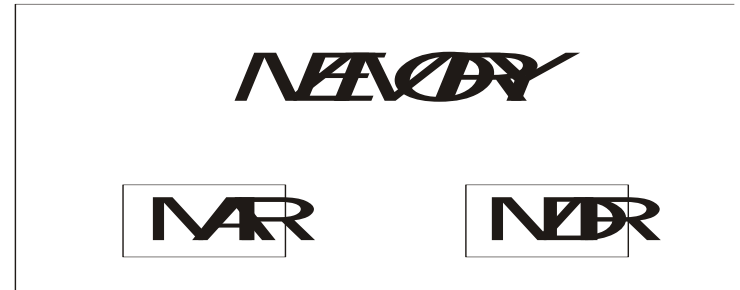

To **LOAD** a location (A):

1. Write the address (A) into the MAR.
2. Send a “read” signal to the memory.
3. Read the data from MDR.

To **STORE** a value (X) to a location (A):

1. Write the data (X) to the MDR.
2. Write the address (A) into the MAR.
3. Send a “write” signal to the memory.

Processing Unit

Functional Units

- ALU = Arithmetic and Logic Unit
- could have many functional units.
some of them special-purpose
(multiply, square root, ...)
- LC-3 performs ADD, AND, NOT
(LC-3 is a computer we are going to build)

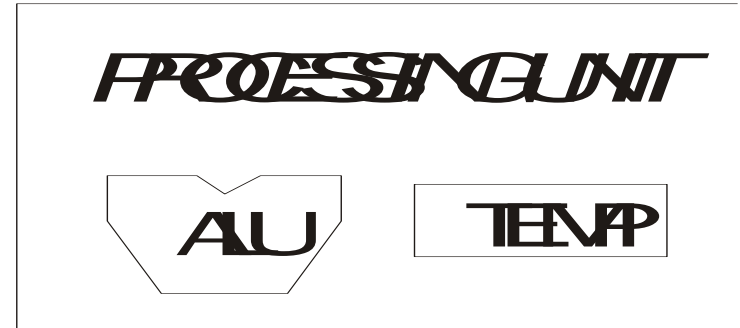

Registers

- Small, temporary storage (TEMP)
- Operands and results of functional units
- LC-3 has eight registers (R0, ..., R7), each 16 bits wide

Word Size

- number of bits normally processed by ALU in one instruction
- also width of registers
- LC-3 is 16 bits

Input and Output

Devices for getting data into and out of computer memory

Each device has its own interface, usually a set of registers like the memory's MAR and MDR

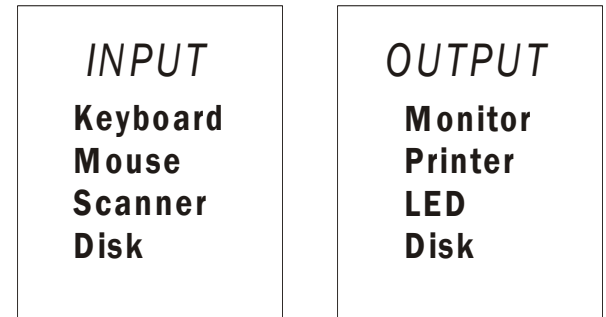

- **LC-3 supports keyboard (input) and monitor (output)**
- **keyboard: data register (KBDR) and status register (KBSR)**
- **monitor: data register (DDR) and status register (DSR)**

Some devices provide both input and output

- **disk, network**

Control Unit

Orchestrates execution of the program



Instruction Register (IR) contains the *current instruction*.

Program Counter (PC) contains the *address* of the next instruction to be executed.

Control unit:

- reads an instruction from memory
 - the instruction's address is in the PC
- interprets the instruction, generating signals that tell the other components what to do
 - an instruction may take many *machine cycles* to complete

Instruction Processing

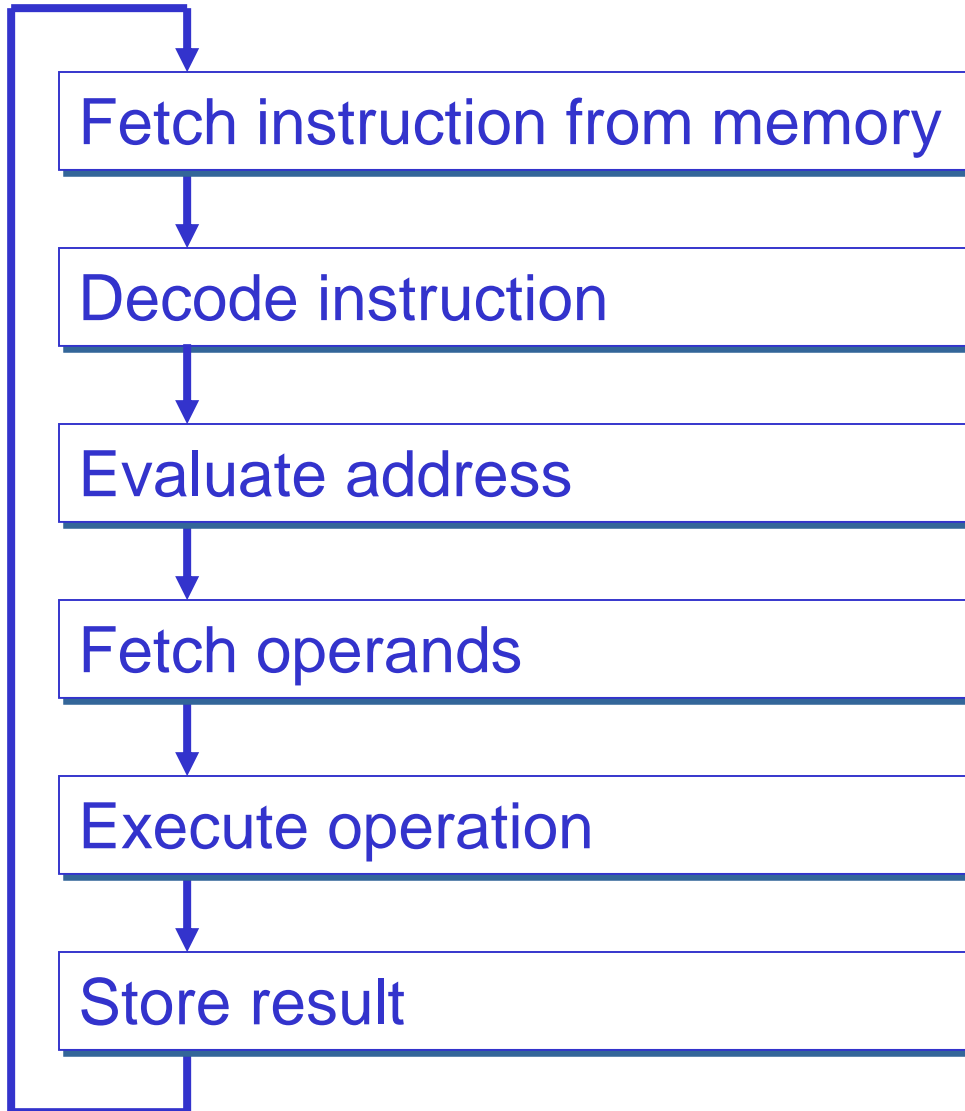

Instruction

The instruction is the fundamental unit of work.

Specifies two things:

- opcode: operation to be performed
- operands: data/locations to be used for operation

An instruction is encoded as a sequence of bits.

(Just like data!)

- Often, but not always, instructions have a fixed length, such as 16 or 32 bits.
- Control unit interprets instruction:
generates sequence of control signals to carry out operation.

A computer's instructions and their formats/semantics are known as its *Instruction Set Architecture (ISA)*.

Example: LC-3 ADD Instruction

LC-3 has 16-bit instructions.

- Each instruction has a four-bit opcode, bits [15:12].

LC-3 has eight *registers* (R0-R7) for temporary storage.

- Sources and destination of ADD are registers.

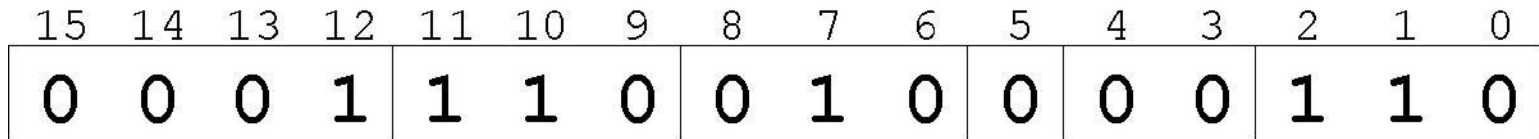
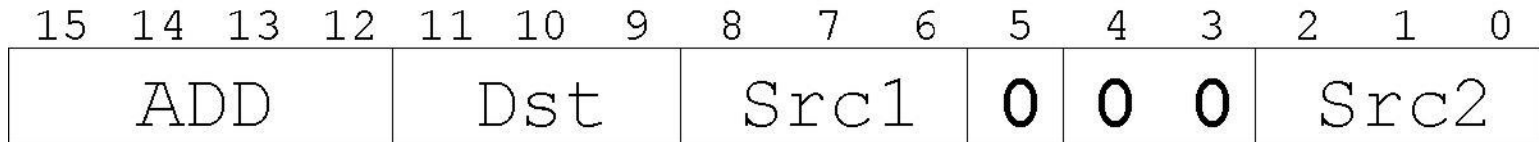

“Add the contents of R2 to the contents of R6, and store the result in R6.”

Example: LC-3 LDR Instruction

Load instruction -- reads data from memory

Base + offset mode:

- **add offset to base register -- result is memory address**
- **load from memory address into destination register**

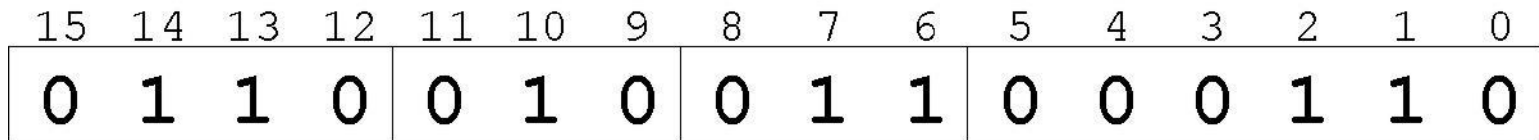
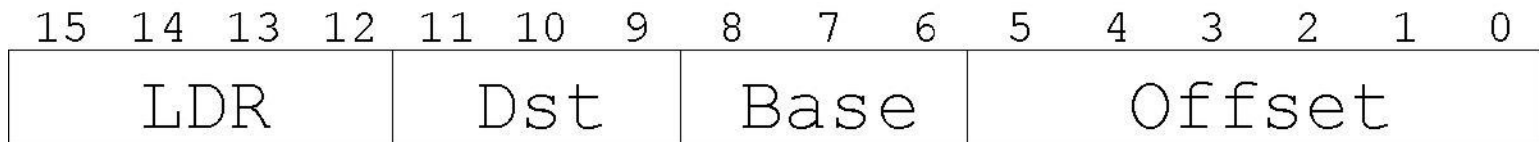

“Add the value 6 to the contents of R3 to form a memory address. Load the contents of that memory location to R2.”

Instruction Processing: **FETCH**

Load next instruction (at address stored in PC) from memory into Instruction Register (IR).

- Copy contents of PC into MAR.
- Send “read” signal to memory.
- Copy contents of MDR into IR.

Then increment PC, so that it points to the next instruction in sequence.

- PC becomes PC+1.

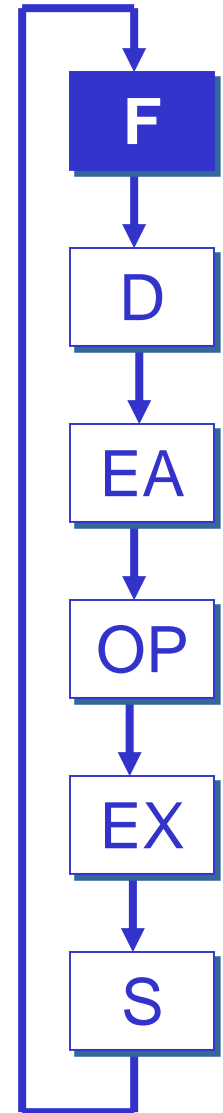

Instruction Processing: DECODE

First identify the opcode.

- In LC-3, this is always the first four bits of instruction.
- A 4-to-16 decoder asserts a control line corresponding to the desired opcode.

Depending on opcode, identify other operands from the remaining bits.

- Example:
 - for LDR, last six bits is offset
 - for ADD, last three bits is source operand #2

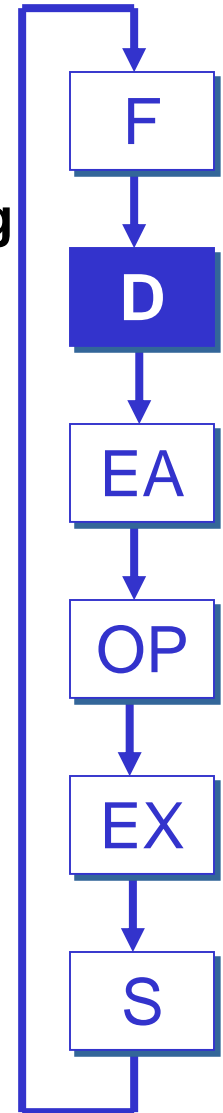

Instruction Processing: EVALUATE ADDRESS

For instructions that require memory access, compute address used for access.

Examples:

- add offset to base register (as in LDR)
- add offset to PC

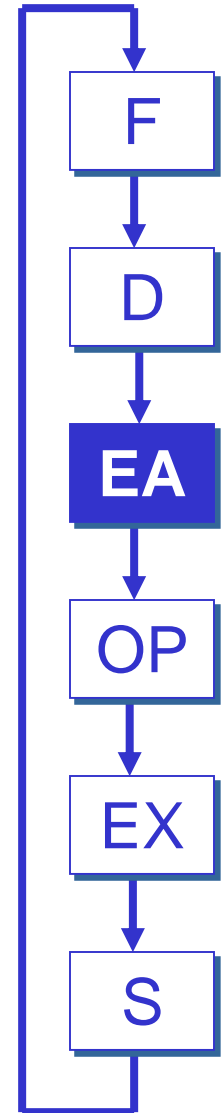

Instruction Processing: **FETCH OPERANDS**

Obtain source operands needed to perform operation.

Examples:

- **load data from memory (LDR)**
- **read data from register file (ADD)**

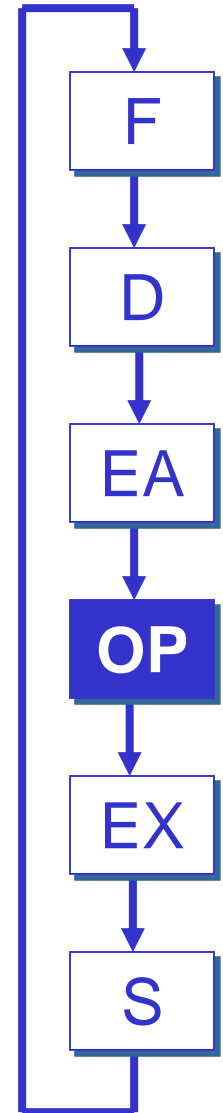

Instruction Processing: EXECUTE

Perform the operation,
using the source operands.

Examples:

- send operands to ALU and assert ADD signal
- do nothing (e.g., for loads and stores)

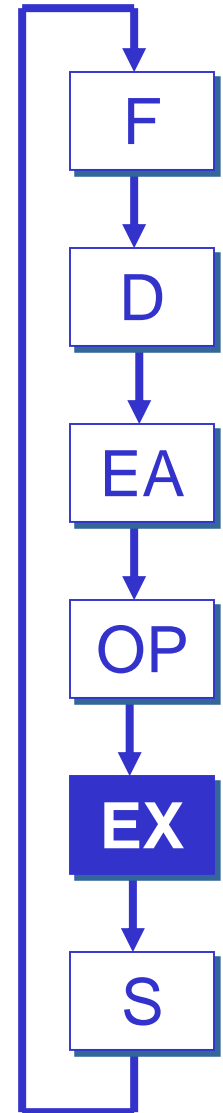

Instruction Processing: STORE RESULT

**Write results to destination.
(register or memory)**

Examples:

- result of ADD is placed in destination register
- result of memory load is placed in destination register
- for store instruction, data is stored to memory
 - write address to MAR, data to MDR
 - assert WRITE signal to memory

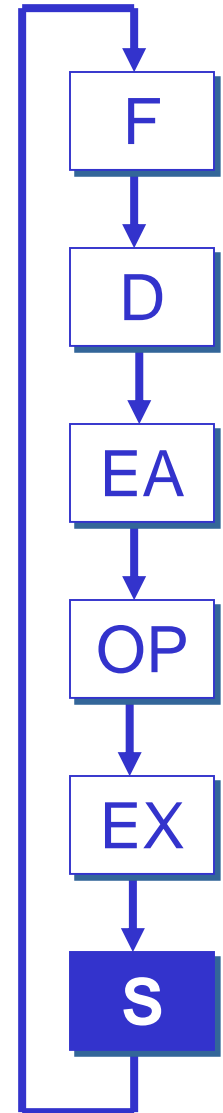

Changing the Sequence of Instructions

In the FETCH phase,
we increment the Program Counter by 1.

What if we don't want to always execute the instruction
that follows this one?

Need special instructions that change the contents
of the PC.

These are called ***control instructions***.

- **jumps** are unconditional -- they always change the PC
- **branches** are conditional -- they change the PC only if some condition is true (e.g., the result of an ADD is zero)

Example: LC-3 JMP Instruction

Set the PC to the value contained in a register. This becomes the address of the next instruction to fetch.

15	14	13	12	11	10	9	8	7	6	5	4	3	2	1	0
JMP				0	0	0	Base			0	0	0	0	0	0

15	14	13	12	11	10	9	8	7	6	5	4	3	2	1	0
1	1	0	0	0	0	0	0	1	1	0	0	0	0	0	0

“Load the contents of R3 into the PC.”

Instruction Processing Summary

Instructions look just like data -- it's all interpretation.

Three basic kinds of instructions:

- **computational instructions (ADD, AND, ...)**
- **data movement instructions**
 - **Memory → Register (LDR)**
 - **Register → Memory (STR)**
- **control instructions (JMP, BRnz, ...)**

Six basic phases of instruction processing:

F → D → EA → OP → EX → S

- **not all phases are needed by every instruction**
- **phases may take variable number of machine cycles**

Control Unit State Diagram

The control unit is a state machine. Here is part of a simplified state diagram for the LC-3:

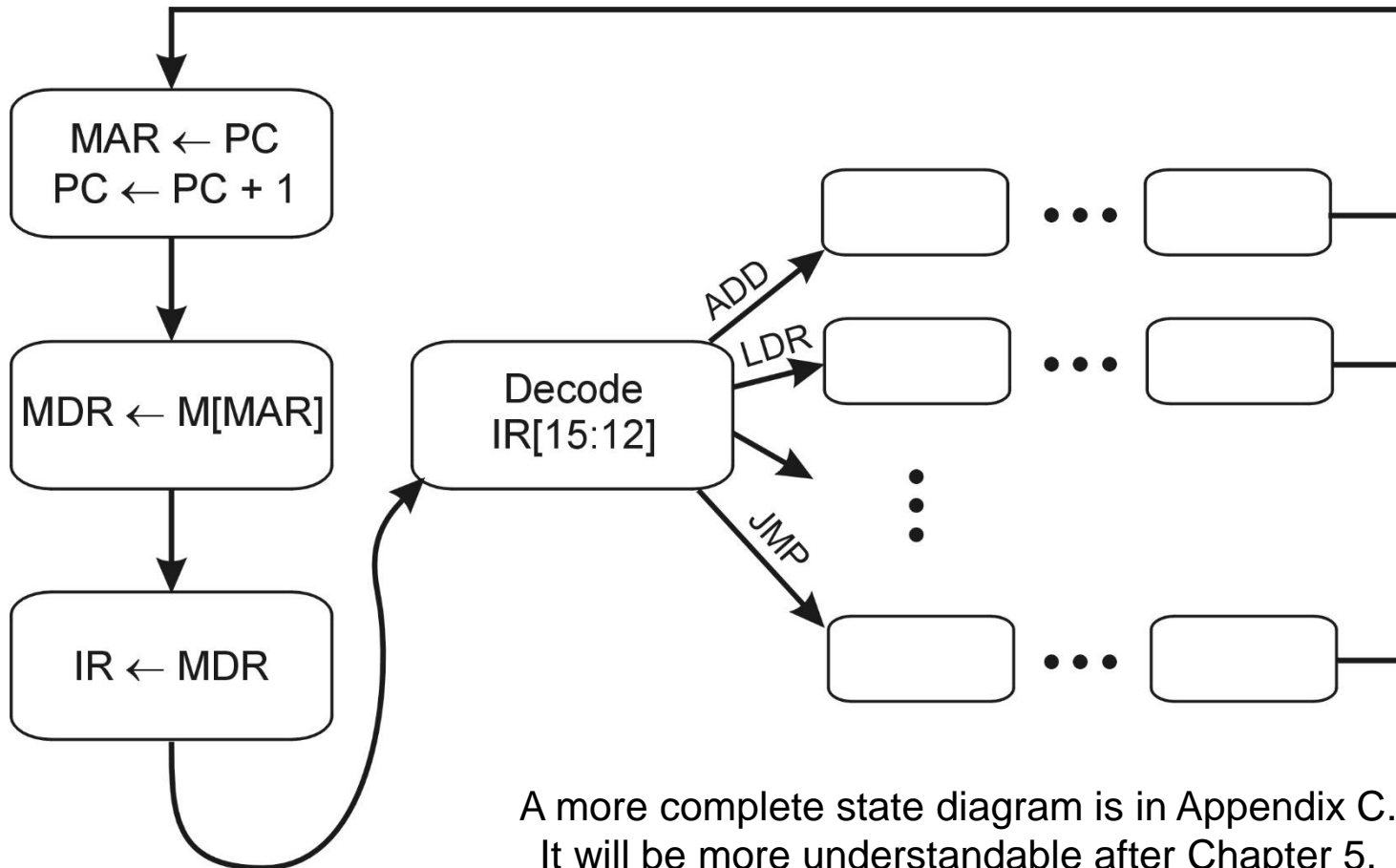

A more complete state diagram is in Appendix C. It will be more understandable after Chapter 5.

Stopping the Clock

Control unit will repeat instruction processing sequence as long as clock is running.

- If not processing instructions from your application, then it is processing instructions from the Operating System (OS).
- The OS is a special program that manages processor and other resources.

To stop the computer:

- AND the clock generator signal with ZERO
- When control unit stops seeing the CLOCK signal, it stops processing.

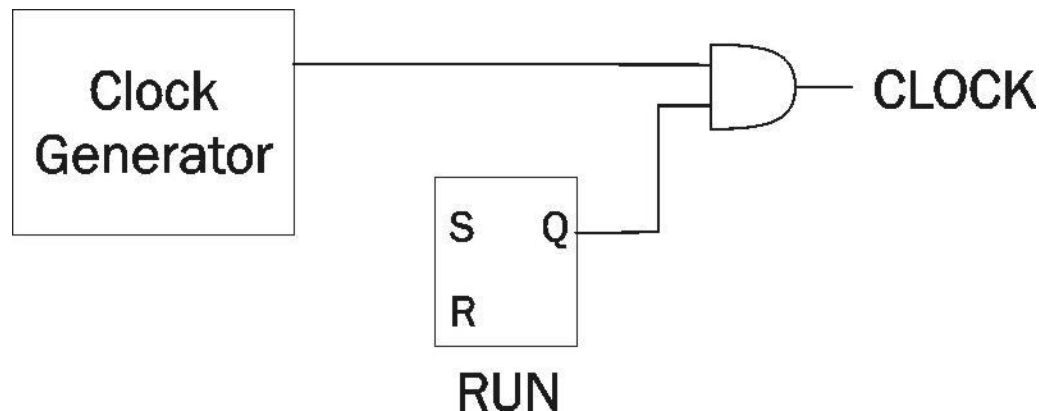

꼭 기억해야 할 것

- Von Neumann Model
 - Processing Unit, Memory, Input, Output, Control Unit
- Instruction Set Architecture – the language of hardware
 - **computational instructions (ADD, AND, ...)**
 - **data movement instructions**
 - **Memory → Register (LDR)**
 - **Register → Memory (STR)**
 - **control instructions (JMP, BRnz, ...)**
- F (Fetch) → D (Decode) → EA (Evaluate Address) → OP (Fetch Operands) → EX (Execute) → S (Store Result)